



# UNCOMPROMISING PERFORMANCE

GP DESIGN CREATING HIGH PERFORMANCE & DURABILITY



## SUPERCOIL

Suzi-Coils



4

## COILMASTER

Suzi-Coils



5

## CENTURION

Suzi-Coils



6

## GLAD HANDS



7

## TEC-CLAMP

Suzi-Coil Clamp & Pogo Stick



8

## HYDRAULIC

Couplers



9

## TRUCKMASTER

Air Brake Filtration



10

## DUMPMASTER

Air Brake Filtration



12

## TURBOMASTER

Air Brake Filtration & Grease seals



14-15

## BEARINGMASTER

Installation & Removal Kits



16

## CONSPICUITY TAPE

Safety Products



17

## AIR BRAKE TUBE

Nylon Tubing, Air Brake Tube Stand



18

## AIR BRAKE D.O.T RUBBER HOSE

Corrugated Split Tube, Hose Clamps,  
Cable Ties

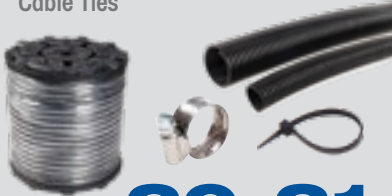

**20-21**

## BREAK DOWN KITS

Spare Parts



**22**

## GLOVE BOX KITS

Spare Parts



**23**

## PUSH TO CONNECT

DOT Fittings



**24**

## COMPRESSION

DOT Fittings

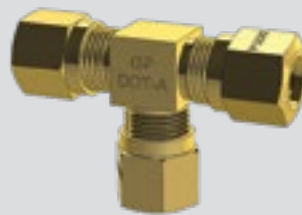

**35**

## BRASS FITTINGS



**39**

## COMPOSITE FITTINGS

Non DOT Fittings



**50**

## AIR COUPLINGS

Truck/Trailer



**53**

## WORKSHOP AIRLINE

Couplings & Adaptors



**57**

## GP DISPLAY STANDS

Suzi-Coil Rack, Coupling Sets



**59**

## FITTING MASTER

Mobile Fitting Rack,  
Fittings Cabinets



**60**

## GP TRUCK PRODUCTS

Designed & Engineered Products  
conforming to ADR -38/05,  
AUSTRALIAN, SAE, ISO and  
DIN standards





# SUPERCOIL ANTI KINK SUZI-COIL



Unique fitting to tube retention

Flexible handle sleeve

NEW Uni-Fit fittings  
Suits Nth American and European Trucks

## SUPERCOIL

### FEATURES

- Compliant Standards: ADR-38/05, Tested to DIN 74323, 74324 & ISO 7375 A1
- **Anti Kink** Thermoplastic Polyurethane material
- Excellent abrasion resistance
- Excellent mechanical properties, combined with a rubber-like elasticity
- Oil and Diesel resistance
- High UV resistance (>4000 hours of Accelerated Testing to ISO 4982-2)
- 40% lighter than traditional Type B Suzi-Coils
- High elasticity with excellent flexibility and recoil memory.
- Compact coil size, diameter 74mm



Part# **GP-7750** Long Tail Coil  
Part# **GP-7000** Short Tail Coil

Regular Suzi-Coil  
130mm Diameter

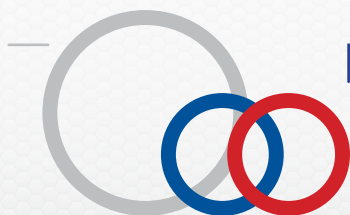

**SUPERCOIL**  
Compact 74mm diameter coil



Unique fitting  
to tube retention

Flexible  
handle sleeve

NEW Uni-Fit fittings  
Suits Nth American and European Trucks

## COILMASTER FEATURES

- Compliant Standards:- ADR-38/05, ISO 7375 & ISO 7628.
- 50% lighter than conventional Type B Suzi-Coils.
- Heavy application performance design
- Unique fitting to tube terminal design & assembly
- Flexible handle sleeves included for positive connection and disconnection of the coupling
- Oil, Diesel and UV resistant
- Excellent flexibility and recoil memory.

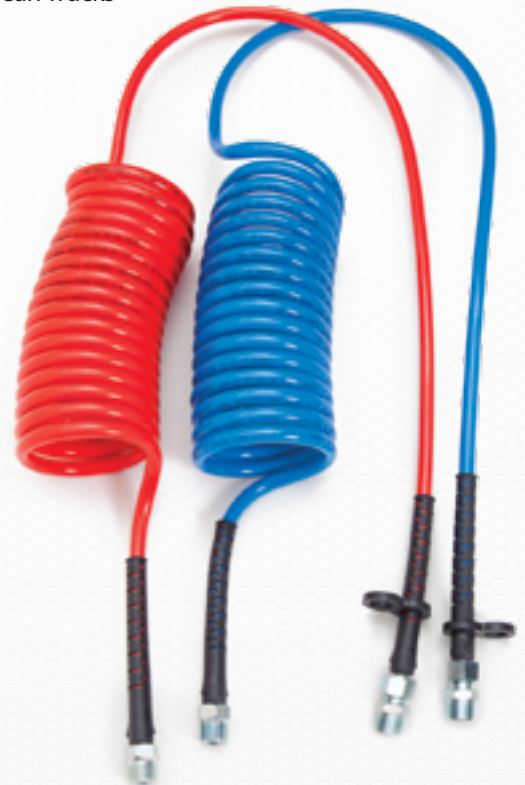

Part# **GP-4750** Long Tail Coil  
Part# **GP-4000** Short Tail Coil



# CENTURION SUPER UV RESISTANCE SUZI-COIL

NEW Uni-Fit fittings (No adaptors required)  
Suits Nth American and European Trucks



Flexible  
handle sleeve

## CENTURION FEATURES

- **Super UV Resistance** (>4000 hours of Accelerated Testing to ISO 4982-2)
- Uni-Fit threads to suit North American & European trucks (No adaptors required)
- Compliant Standards: ADR-38/05, Tested to DIN 74323, 74324 & ISO 7375 A1, ATE-008
- **Anti Kink & Tangle Free** Thermoplastic Polyurethane material
- Excellent abrasion resistance
- Excellent mechanical properties, combined with a rubber-like elasticity
- Oil and Diesel resistance
- 40% lighter than traditional Type B Suzi-Coils
- High elasticity with excellent flexibility and recoil memory.
- Compact coil size, diameter 60mm

## CENTURION

Compact 60mm  
diameter coil

Regular  
Suzi-Coil  
130mm  
Diameter

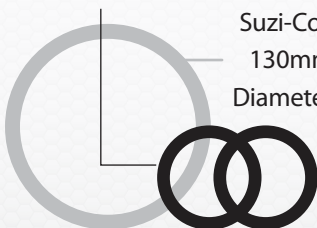

Part# **GP-8000** Short Tail

Part# **GP-8750** Long Tail



## GLAD HANDS

### INSECT & DIRT RESISTANT

- GP-928-S08** Service Glad Hand with Open Rubber Seal & Filter
- GP-928-E08** Emergency Glad Hand with Open Rubber Seal & Filter
- GP-929-S08** Service Glad Hand with Closed Rubber Seal & Filter
- GP-929-E08** Emergency Glad Hand with Closed Rubber Seal & Filter

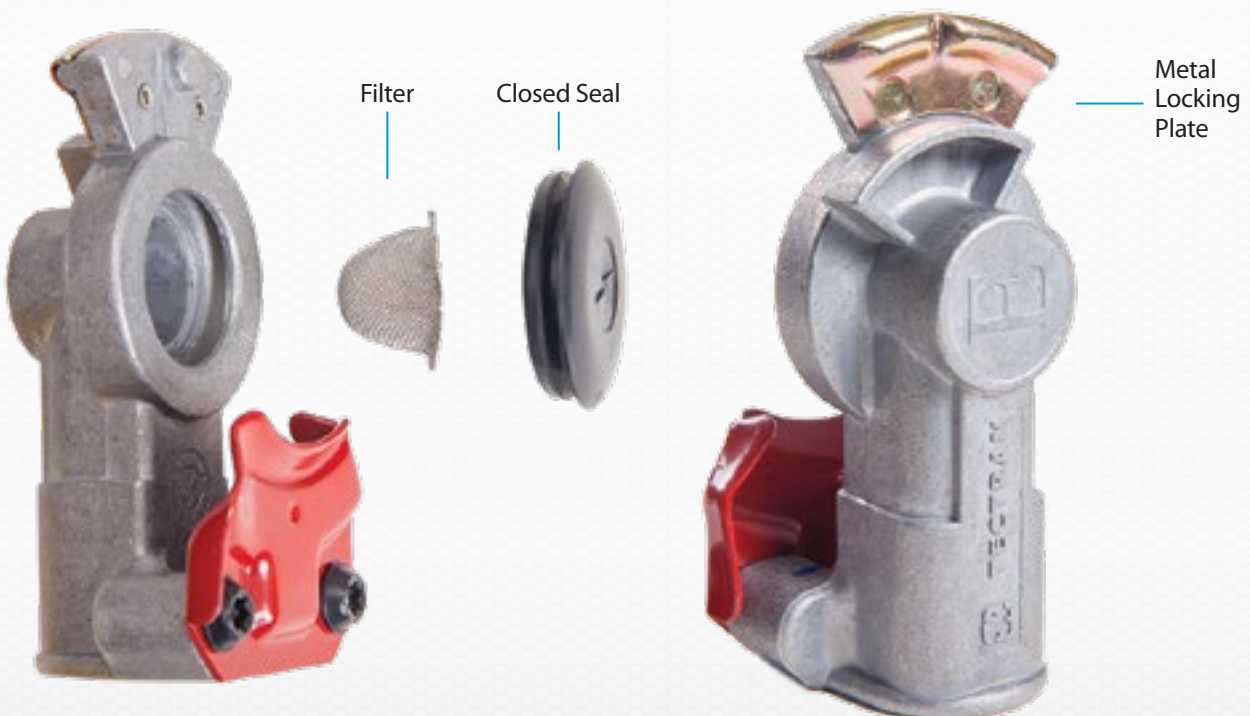



# TEC-CLAMP

## TEC-CLAMP SUZI-COIL CLAMP

### TEC-CLAMP SUZI-COIL CLAMP

Hooking-up trailer connection lines just got easier!

The **NEW 4 HOLE** TEC-CLAMP allows you to lock in your lines and go! No tools or hardware needed for fast, easy installations!

Versatile design can be used with both rubber air hose or coiled tubing hook-ups.

#### TEC-CLAMP FEATURES

Heavy duty clamp design. Superior strength and high performance in the most extreme application environments.

Optional, red "power" tab provides maximum application versatility

Part# **GP-9888** 3 hole  
Part# **GP-9889** NEW 4 hole

**NEW**

E-Coated clip for use with both Tender Kit & Pogo Stick suspension devices.

"Hose Keeper" holds each line in place while installing the other lines.

Part# **GP-925-C**  
Chromed steel heavy duty Pogo Stick

Part# **GP-925-C3**  
Chromed Pogo stick with 3 hole Tec-Clamp

Part# **GP-925-C4**  
Chromed Pogo stick with 4 hole Tec-Clamp





## HYDRAULIC COUPLERS FEATUTRES

The IRH series brings to the industry a proven design for use on construction equipment, forestry equipment, agricultural machinery, oil tools and other demanding hydraulic applications.

- Poppet valves open automatically when coupled.
- Optimised internal flow channel provides better flow performance.
- Critical parts are hardened for durability.
- Socket and plug are precision machined from solid bar stock.
- Compatible with TEMA TH series, STUCCHI series.
- Uncoupled leakage prevented due to incorporated poppet valve.
- NBR O Ring
- Dependable ball-locking mechanism holds the mating halves together.
- BSPP Female Threads

Hydraulic Apaptors	
Part Number	BSPP
GP-900-7500	3/4"
GP-900-10000	1"

Hydraulic Couplings	
Part Number	BSPP
GP-901-7500	3/4"
GP-901-10000	1"





# TRUCKMASTER AIR BRAKE FILTRATION

ELIMINATE OIL, WATER,  
SLUDGE & CARBON FROM  
YOUR AIR-BRAKE SYSTEM!

## The benefits of fitting TruckMaster Filter to your vehicle Air-Brake system:

- No desiccants, chemicals or replacement filters.
- One quick (25 min) service every 120,000 kms.
- Does not rely on compressor governor valve
- Does not block or stick.
- No purge valves – No purge tanks or purge cycle.
- Electronic actuation of drain valves.
- Eliminate expensive cartridge costs.



Truckmaster ETP-500-12/24V assembled to truck chassis  
International Patents Apply



## TRUCKMASTER ETP-500-12/24V



### The ultimate setup

Truckmaster ETP-500-12/24V  
includes Dumpmaster EXT-50  
and Dumpmaster XD-30 to  
drain a second tank.

SIMPLE AND COST EFFECTIVE!  
SERVICE TRUCKMASTER FILTER WITHIN MINUTES.



## TRUCKMASTER SERVICE KIT-505

- Bolt, washer & locknut
- Bronze pre-filter
- Expansion manifold o-ring
- Cap o-ring
- Coalescing tube o-ring
- Circlips
- Stainless steel mesh set

### SERVICE PERIOD:

Recommended servicing every  
120,000 kms

### EXCEPTIONS:

Waste vehicles service at least  
4 times a year.



TruckMaster® Filter service KIT-505

Item #	Qty	Description
3	1	M5 Screw Set
5	1	Bronze Pre-Filter
7	1	Cap O-Ring
7a	1	Expansion Manifold O-Ring
7b	1	Coalescing Tube O-Ring
9	2	Circlips
10	5	Stainless Steel Meshes

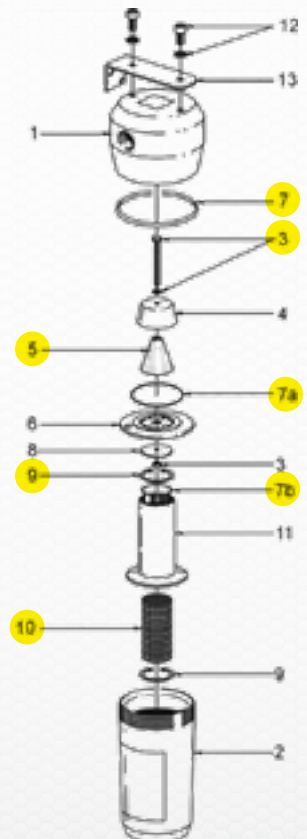

AUTOMATICALLY DRAIN MOISTURE & WATER FROM YOUR TRUCK & TRAILER AIR-BRAKE SYSTEM TANKS!



TRUCK

NSN: 4810-66-155-9895

### DUMPMASTER EXT-50

Drains your Truck Air Brake System tanks of all liquid contaminants electronically every 6 minutes.

### TRAILMASTER EXP-40

Drains your Trailer Air Brake System tanks of all liquid contaminants electronically after 30 seconds of brake application.



TRAILER



TRUCK

NSN: 4820-66-155-9896

### DUMPMASTER XD-30

XD-30 Drain Valves can be used independently if connected to your governor valve or in conjunction with the EXT-50 & EXP-40 to automatically drain a second or third air tank.



# DUMPMASTER SERVICE KIT

A SIMPLE 15 MINUTE INSPECTION AND SERVICE WILL ENSURE PROPER OPERATION AND LONG LIFE OF THE DUMPMASTER DRAIN VALVE.



## DUMPMASTER SERVICE KIT XD-102

- Bolt & locknut
- Spring Retainer
- Flat Washer
- Stainless Steel Spring
- Actuator Seal
- Exhaust Seal
- O-Ring x 2
- Magnalube 4cc

### SERVICE PERIOD:

Recommended twice per year or every 120,000 kms

### EXCEPTIONS:

Waste vehicles service at least 4 times a year.



### DumpMaster Service KIT XD-102

Item#	Part #	Description
6	XD-06	Bolt
7	XD-07	Locknut
9	XD-09	Spring Retainer
10	XD-10	Flat Washer
11	XD-11	Stainless Steel Spring
12	XD-12	Actuator Piston Seal
13	XD-13	Exhaust Seal
14	XD-14	O-Ring
15	XD-15	O-ring

SLASH YOUR CARTRIDGE COSTS!  
MADE FOR AUSTRALIAN CONDITIONS.



TurboMaster is an Australian Made "ADAPTOR" that has been specifically designed to allow fitting of a cost effective WABCO/BENDIX\* type Desiccant "Spin-On" Cartridge onto a CR/SKF Turbo 2000 Air Dryer.

### The benefits of fitting TurboMaster to your vehicle Air-Brake system:

- Cost effective. Utilises WABCO/BENDIX desiccant cartridges
- \$\$ savings of 75% - 80% off the original CR-Turbo 2000 (T224) cartridge
- Weight reduction. TurboMaster and WABCO/BENDIX cartridge weighs 1.5 kg lighter than CR- Turbo 2000 (T224) cartridge
- Readily available from truck outlets Australia wide.



GP-300-02

### PART NUMBERS.

**GP-300-01:** Adaptor Only

**GP-300-02:** Adaptor with Filter

**GP-300-03:** Filter Only

**GP-300-04:** O-Ring Service Kit



GP-300-01

SPECIFICALLY DESIGNED  
FOR GREASE TRAILER AXLES

## GREASE SEALS

- Prevent harmful contaminants from entering the wheel end



### CROSS-REFERENCE TABLE

GP SEAL	C.R	C.R PLUS	NATIONAL	BARRIER	STEMCO GREASE
GS-0713	40136	40133	370036	747400	STM-0744G
GS-0723	42623	42622	370065	745400	STM-0723G
GS-0743	46305	46304	370025	755400	STM-0743G
GS-0744	43753	47352	370037	749400	STM-0744G

**Note:** Grease lubrication applications only.

SAFETY AND PRECISION, WHEN INSTALLING & REMOVING BEARING CUPS!

## BEARINGMASTER

Installs and removes bearing cups safely and precisely without damaging hubs.

### INSTALLATION KIT – GP-TBS-100

A must for all workshops involved with heavy vehicle maintenance. Real time \$\$ savings by avoiding costly re-work from incorrect installation.

### REMOVAL KIT – GP-TBS-200

Includes tool heads to suit various drive, steer and trailer bearing cups.



BearingMaster Kit Contents		
Intaller	Remover	Description
GP-572-1	GP-572-2	Tool Head
GP-592-1	GP-592-2	Tool Head
GP-2011-1	GP-2011-2	Tool Head
GP-3720-1	GP-3720-2	Tool Head
GP-8210-1	GP-8210-2	Tool Head
GP-C1200	GP-C1200	Collet
GP-100	GP-100	Handle
GP-LP-04	GP-LP-04	Lynch Pin
TB-100	TB-200	Tool Box
Additional Tool Heads		
GP-33116-1	GP-33116-2	Tool Head
GP-32310-1	GP-32310-2	Tool Head
GP-552A-1	GP-552A-2	Tool Head
GP-6420-1	GP-6420-2	Tool Head
GP-45220-1	GP-45220-2	Tool Head
GP-518410-1	GP-518410-2	Tool Head

Available For :  
BPW, DANA, YORK, MERITOR, EATON,  
HENDRICKSON, INGERSOLL, K-HITCH,  
TMC etc.

**NOTE:**

Kits include tool heads  
Additional tool heads available

## GREASE PACKER

- Ease of grease lubrication for Truck & Trailer bearings
- No hand contact
- No mess

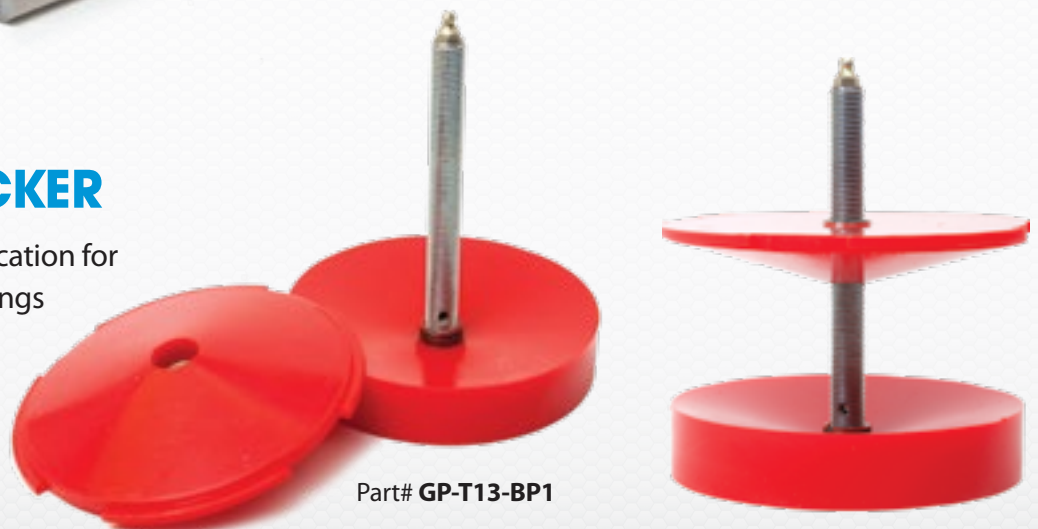





# CONSPICUITY TAPE SAFETY PRODUCTS



BE SEEN, BE SAFE.

## CONSPICUITY TAPE, SAFETY PRODUCTS

GP Truckproducts now stocks a full range of conspicuity tapes with excellent reflective properties. Boasting rigid or flexible options and increased adhesive quality, the tapes are very durable and are available in continuous or segmented lengths. The tapes are available in three different highly visible colours, yellow, white and red. All tapes are compliant to ADR 38/05.



Series 983

### 3M™ RIGID SURFACES CONTINUOUS TAPE



Yellow

**GP-7165** 50MT x 50MM

**GP-7165-S** 12.5MT x 50MM



White

**GP-7168** 50MT x 50MM

**GP-7168-S** 12.5MT x 50MM



Red

**GP-7167** 50MT x 50MM

**GP-7167-S** 12.5MT x 50MM

Series 983

### 3M™ RIGID SURFACES (TANKER) SEGMENTED OVAL TAPE

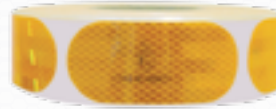

Yellow

**GP-7177** 50MT x 50MM

**GP-7177-S** 12.5MT x 50MM



White

**GP-7179** 50MT x 50MM

**GP-7179-S** 12.5MT x 50MM



Red

**GP-7178** 50MT x 50MM

**GP-7178-S** 12.5MT x 50MM

Series 997

### 3M™ CURTAIN SURFACES CONTINUOUS TAPE



Yellow

**GP-7171** 50MT x 50MM

**GP-7171-S** 12.5MT x 50MM



White

**GP-7172** 50MT x 50MM

**GP-7172-S** 12.5MT x 50MM



Red

**GP-7173** 50MT x 50MM

**GP-7173-S** 12.5MT x 50MM

Series 997

### 3M™ CURTAIN SURFACES SEGMENTED TAPE

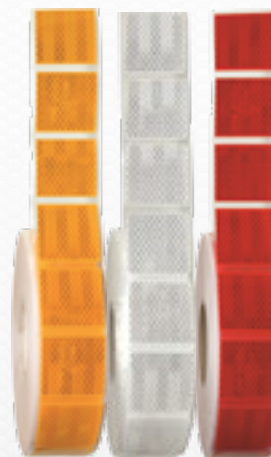

Yellow

**GP-7174** 50MT x 50MM

**GP-7174-S** 12.5MT x 50MM

White

**GP-7175** 50MT x 50MM

**GP-7175-S** 12.5MTT x 50MM

Red

**GP-7176** 50MT x 50MM

**GP-7176-S** 12.5MTT x 50MM

featuring products from:



Authorized Converter  
Safety and Marking Tapes





## AIR BRAKE TUBE

Conformity to Australian Design Rules ADR-38/05 and performance conformity to ISO 7628, SAE J844, DIN 74323 and DIN 74324. All tubing is extruded using the latest machinery and measurement devices. Polyamide 12 Heat and UV stabilised materials.

Black, Blue, Red, Green, Yellow, Orange colors available in 3/8" Tube. White and Grey also available in 1/4" Tube.

Black, Blue, Red, colours available in 1/2" Tube & 8mm Tube. Used in Truck and Trailer Air Brake applications.



UTILISE VERTICAL STORAGE WITH OUR AIR BRAKE NYLON TUBE STAND!

## AIR BRAKE TUBE STAND

### TUBE STAND SUITABLE FOR:

- Truck Trailer Air Brake Tube
- Nylon Tubing
- Corrugated Split Tube
- Rubber Hose

### STORE ROLLS OF NYLON TUBE WITH EASY ACCESS TO A RANGE OF SIZES.

- Unique reel stand used for storing and dispensing of tube
- Grommets for tube size 1/4"(6mm), 5/16"(8mm), 3/8"(10mm) & 1/2"(12mm) tube
- Grommets hold the tube in place when not in use



Part# **GP-TS**  
2215 (H) x 1112 (W) x 740 (D) mm

### COLOURS & SIZES CHART

Size 1/4"



Size 8mm



Size 3/8"



Size 1/2"





## IMPERIAL AIR BRAKE TUBE

SAE J844 / ISO 7628

PART #	OD TUBE	COLOUR	REEL SIZE
GP-5/32A-BK	5/32	BLACK	25-50-100
GP-03A-BK	3/16	BLACK	25-50-100
GP-04A-BK	1/4	BLACK	25-50-100
GP-04A-RD	1/4	RED	25-50-100
GP-04A-BL	1/4	BLUE	25-50-100
GP-04A-GN	1/4	GREEN	25-50-100
GP-04A-YL	1/4	YELLOW	25-50-100
GP-04A-OR	1/4	ORANGE	25-50-100
GP-04A-WH	1/4	WHITE	25-50-100
GP-04A-GY	1/4	GREY	25-50-100
GP-05A-BK	5/16	BLACK	25-50-100
GP-06B-BK	3/8	BLACK	25-50-100
GP-06B-RD	3/8	RED	25-50-100
GP-06B-BL	3/8	BLUE	25-50-100
GP-06B-GN	3/8	GREEN	25-50-100
GP-06B-YL	3/8	YELLOW	25-50-100
GP-06B-OR	3/8	ORANGE	25-50-100
GP-08B-BK	1/2	BLACK	25-50-100
GP-08B-RD	1/2	RED	25-50-100
GP-08B-BL	1/2	BLUE	25-50-100
GP-10B-BK	5/8	BLACK	25-50-100

## METRIC AIR BRAKE TUBE

ISO 7628

PART #	OD TUBE	COLOUR	REEL SIZE
GP-4-2-BK	4mm X 2mm	BLACK	25-50-100
GP-6-4-BK	6mm X 4mm	BLACK	25-50-100
GP-8-6-BK	8mm X 6mm	BLACK	25-50-100
GP-8-6-RD	8mm X 6mm	RED	25-50-100
GP-8-6-BL	8mm X 6mm	BLUE	25-50-100
GP-10-7.5-BK	10mm X 7.5mm	BLACK	25-50-100
GP-12-9-BK	12mm X 9mm	BLACK	25-50-100
GP-15-12-BK	15mm X 12mm	BLACK	25-50-100
GP-16-12-BK	16mm X 12mm	BLACK	25-50-100

## IMPERIAL AIR BRAKE TUBE

ISO 7628

PART #	OD TUBE	COLOUR	REEL SIZE
GP-06A-BK	3/8 OD TUBE	BLACK	25-50-100
GP-06A-RD	3/8 OD TUBE	RED	25-50-100
GP-06A-BL	3/8 OD TUBE	BLUE	25-50-100



## TUBE CUTTERS

Part# **GP-TSNIP**



Part# **GP-HDCUT**



## SUPERIOR QUALITY AIR BRAKE HOSE

### AIR BRAKE D.O.T RUBBER HOSE

- Made in the U.S.A by Contitech.
- Designed for compressed air brake systems for trucks & buses.
- Reinforced with braided synthetic cord for high performance strength.
- 3/8 and 1/2 meet SAE J 1402 specifications and complies with DOT FMVSS 106
- 3/4 meets SAE J 1403 specifications and complies with DOT FMVSS 106VH
- Black seamless, oil heat and weather resistant synthetic rubber
- Resistant to harmful grease and oil common to Air Brake systems
- Flexible and kink resistant
- Designed to suit all styles of couplings
- Temperature rating -40oc to +100oc



#### Air Brake DOT Rubber Hose

PART #	ID Size	Reel Length	PSI
GP-RH-06	3/8	76.2mt	225
GP-RH-06L	3/8	152.4mt	225
GP-RH-08	1/2	76.2mt	225
GP-RH-08L	1/2	152.4mt	225
GP-RH-012	3/4	Cut to length	350
GP-RH-012L	3/4	152.4mt	350

#### Horizon Non DOT Rubber Hose

PART #	ID Size	Reel Length	PSI
GP-RH-012H	3/4	Cut to length	200
GP-RH-012HL	3/4	152.4mt	200

**NOTE:** PSI equals max working pressure



Part# **GPHA-0806-20**  
DOT Air Brake Hose 20"

### RUBBER HOSE ASSEMBLIES

- Flexible and kink resistant SAE J1402 Air Brake Hose
- Complies with DOT FMVSS 106 requirements
- Couplings meet SAE and DOT minimum pull-off requirements
- High quality brass male pipe fitting on one end, female air brake swivel with male pipe adaptor on other end
- Temperature rating: -40°C to +100°C

#### Dot Air Brake Hose Assemblies

Part #	Hose I.D	Male N.P.T	A.B.S** Thread	Overall Length	Cross Reference
GPHA-0806-18	1/2"	3/8-18	7/8-20	18"	WF38353.01800
GPHA-0806-20	1/2"	3/8-18	7/8-20	20"	WF38353.02000
GPHA-0806-22	1/2"	3/8-18	7/8-20	22"	WF38353.02200
GPHA-0806-24	1/2"	3/8-18	7/8-20	24"	WF38353.02400
GPHA-0806-26	1/2"	3/8-18	7/8-20	26"	WF38353.02600
GPHA-0806-28	1/2"	3/8-18	7/8-20	28"	WF38353.02800
GPHA-0806-30	1/2"	3/8-18	7/8-20	30"	WF38353.03000
GPHA-0806-32	1/2"	3/8-18	7/8-20	32"	WF38353.03200
GPHA-0806-34	1/2"	3/8-18	7/8-20	34"	WF38353.03400
GPHA-0806-38	1/2"	3/8-18	7/8-20	38"	WF38353.03800

**NOTE:** Customised lengths available upon request



# CORRUGATED SPLIT TUBE



## CORRUGATED SPLIT TUBE

- Black U.V. stabilised, halogen free flame retardant polypropylene.
- Operating temperature -25C to +110C, high temperature heat stabilisation

Corrugated Split Tube		
Part #	Description	Cross Reference
GP-ST7-400	7mm x 400MT PP Split Tube	56709 (200mt)
GP-ST10-250	10mm x 250MT PP Split Tube	56712 (125mt)
GP-ST13-150	13mm x 150MT PP Split Tube	56715 (75mt)
GP-ST16-100	16mm x 100MT PP Split Tube	56718 (50mt)
GP-ST20-100	20mm x 100MT PP Split Tube	56722 (50mt)
GP-ST23-50	23mm x 50MT PP Split Tube	56725 (50mt)
GP-ST29-50	29mm x 50MT PP Split Tube	56731 (40mt)
GP-ST36-25	36mm x 25MT PP Split Tube	56737 (25mt)
GP-ST48-25	48mm x 25MT PP Split Tube	56749 (25mt)

## CABLE TIES

- UV Stabilised Cable Ties in black nylon (V2-UL 94)
- For external applications
- Resistant to temperatures of -20°C to +80°C. Black
- Resistant to solvent and reagents, oils and petrol



Cable Ties				
Part #	Width	Length	Pack Qty	Cross Reference
GP-564-35140	3.5mm	140mm	100 pcs	56302 (3.5 X 140)
GP-564-45200	4.5mm	200mm	100 pcs	56404 (4.8 X 200)
GP-564-75200	7.5mm	200mm	100 pcs	N/A
GP-564-45280	4.5mm	280mm	100 pcs	56406 (4.8 X 300)
GP-564-45360	4.5mm	360mm	100 pcs	56408 (4.8 X 370)
GP-564-75320	7.5mm	320mm	100 pcs	N/A
GP-564-75360	7.5mm	360mm	100 pcs	56410 (7.6 X 370)
GP-564-75540	7.5mm	540mm	100 pcs	N/A
GP-564-90780	9.0mm	780mm	50 pcs	N/A

## HOSE CLAMPS

- Zinc plated band and screw
- Stainless steel band with zinc screw



Hose Clamps	
Zinc Plated	Stainless Steel
GP-HC-M8-12	GP-HC-M13-23SS
GP-HC-M10-16	GP-HC-M14-27SS
GP-HC-M12-22	GP-HC-M17-32SS
GP-HC-M16-27	GP-HC-M21-44SS
GP-HC-M20-32	
GP-HC-M25-40	

**NOTE:** Other Sizes Available on Request



GP BREAKDOWN KIT OFFERS IMMEDIATE AND EFFECTIVE REPAIR. INCLUDING BOTH METRIC AND IMPERIAL JOINERS, TEES AND BLANKING PLUGS.

## BREAKDOWN KIT GPKT-6264-01

- Make immediate repair to vehicles
- Get truck & trailer back on the road quickly
- Covers a wide range of truck and trailer popular tube sizes
- Keep stock of emergency DOT Air Brake Fittings
- Internal contents label for re-ordering
- Top up your kit as fittings are used
- Kit includes a tube cutter
- 20 compartment compact clear carry pack
- Spare parts access 24/7
- ADR 38/05 Compliant DOT Air Brake Fittings
- Blanking plugs included in kit



Dimensions: 350 x 270 x 55mm



GPKT-6264-01		
Part #	Qty	Description
DQ62P02	2	1/8 Tube Joiner - NON DOT
DQ62DOT5/32	2	5/32 Tube Joiner
DQ62DOT04	2	1/4 Union/Joiner
DQ62DOT06	2	3/8 Union/Joiner
DQ62DOT08	2	1/2 Union/Joiner
DQ62DOT10	2	5/8 Union/Joiner
DQ64DOT5/32	1	5/32 Tee
DQ64DOT04	1	1/4 Union Tee
DQ64DOT06	1	3/8 Union Tee
DQ64DOT08	1	1/2 Union Tee
MDQ62DOT6	2	6mm Union Joiner
MDQ62DOT8	2	8mm Union Joiner
MDQ62DOT10	2	10mm Union Joiner
MDQ62DOT12	2	12mm Union Joiner
MDQ62DOT16	1	16mm DOT Joiner
MDQ64DOT6	1	6mm Union Tee
MDQ64DOT8	1	8mm Union Tee
MDQ64DOT10	1	10mm Tube Tee
MDQ64DOT12	1	12mm Union Tee
GP-TSNIP	1	Tube Cutter
GP-064-P04	1	1/4 Tube Plug
GP-064-P06	1	3/8 Tube Plug
GP-064-P08	1	1/2 Tube Plug
GP-064-P6	1	6mm Tube Plug
GP-064-P8	1	8mm Tube Plug
GP-064-P10	1	10mm Tube Plug
GP-064-P12	1	12mm Tube Plug



GP-TSNIP

## 24HR EMERGENCY AIR BRAKE SOLUTIONS

### GLOVE BOX KITS

- Keeping your vehicle on the road
- ADR 38/05 Compliant DOT Air Brake Fittings
- Joiners to suit most common tube sizes
- Prevent costly down-time
- Available in Metric and Imperial Kits
- Kits include a tube cutter
- Clear compact, 5 compartment carry pack
- Blanking plugs included

#### GLOVE BOX KIT GPKT-6264-02



- Imperial Kit
- Blanking plugs included
- Dimensions:  
190 x 120 x 30mm



GPKT-6264-02		
Part #	Qty	Description
DQ62P02	1	1/8 Tube Joiner - NON DOT
DQ62DOT5/32	1	5/32 Tube Joiner
DQ62DOT04	1	1/4 Union/Joiner
DQ62DOT06	1	3/8 Union/Joiner
DQ62DOT08	1	1/2 Union/Joiner
DQ64DOT5/32	1	5/32 Union Tee
DQ64DOT04	1	1/4 Union Tee
DQ64DOT06	1	3/8 Union Tee
DQ65DOT06	1	3/8 90 deg Union Elbow
GP-064-P04	1	1/4 Tube Plug
GP-064-P06	1	3/8 Tube Plug
GP-064-P08	1	1/2 Tube Plug
GP-TSNIP	1	Tube Cutter

**NOTE:** Customised kits can be made upon request

#### GLOVE BOX KIT GPKT-6264-03



- Metric Kit
- Blanking plugs included
- Dimensions:  
190 x 120 x 30mm



**NOTE:** Customised kits can be made upon request

GPKT-6264-03		
Part #	Qty	Description
MDQ62DOT6	1	6mm DOT Union Joiner
MDQ62DOT8	1	8mm DOT Union Joiner
MDQ62DOT10	1	10mm DOT Union Joiner
MDQ62DOT12	1	12mm DOT Union Joiner
MDQ65DOT8	1	8mm 90 deg Union Joiner
MDQ64DOT6	1	6mm Tube Tee
MDQ64DOT8	1	8mm Tube Tee
GP-064-P6	1	6mm Tube Plug
GP-064-P8	1	8mm Tube Plug
GP-064-P10	1	10mm Tube Plug
GP-064-P12	1	12mm Tube Plug
GP-TSNIP	1	Tube Cutter

# DOT PUSH TO CONNECT FITTINGS

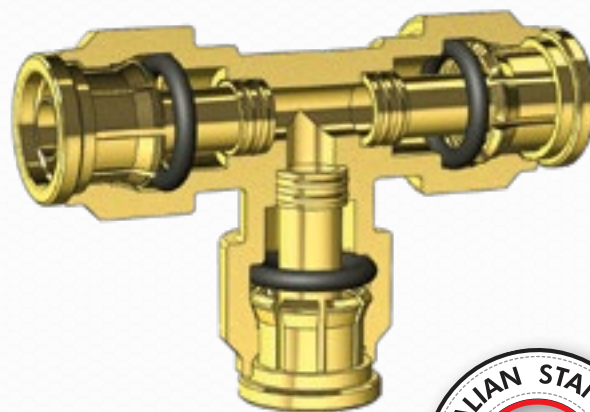

---

## CONFORMITY TO:

DOT - DEPARTMENT OF TRANSPORT

APPROVED TO MEET:

AUSTRALIAN DESIGN RULES ADR-38/05

DOT FMVSS 571.106, SAE J2494/3, SAE J1131

---





# DOT PUSH TO CONNECT FITTINGS

## FITTING IDENTIFICATION CHART

Below is the formula we use to create our Part numbers for the DOT Air Brake Push-in Fittings. Here is an example and the breakdown of a typical part number.



EG. - MDQ69DOTS6M12

Metric Male Elbow DOT Swivel 6mm Tube to Metric 12mm Thread

## WE HAVE THE RANGE:

### IMPERIAL TUBE TO IMPERIAL THREAD

DQ68DOT0604

Imperial Tube - Male Connector - DOT - 3/8" OD Tube - 1/4" NPTF Thread

### IMPERIAL TUBE TO METRIC THREAD

DQ69DOTS06M22

Imperial Tube - Male Elbow - DOT- Swivel - 3/8" OD Tube - M22 Thread

### METRIC TUBE TO IMPERIAL THREAD

MDQ68DOT806

Metric Tube - Male Connector - DOT - 8mm OD Tube - 3/8" NPTF Thread

### METRIC TUBE TO METRIC THREAD

MDQ69DOTS12M16

Metric Tube - Male Elbow - DOT - Swivel - 12mm OD Tube - M16 Thread

Conformity to:

DOT = Department Of Transport

Approved to meet:

- Australian Design Rules ADR 38/05
- DOT FMVSS 571.106
- SAE J2494/3
- SAE J1131

DOTS = "S" is optional and denotes a swivel fitting.

## STYLE OF FITTING

54	45 DEG MALE ELBOW	
62	UNION - JOINER	
64	UNION - TEE	
65	UNION - ELBOW	
66	FEMALE CONNECTOR	
68	MALE CONNECTOR	
69	MALE ELBOW	
70	FEMALE ELBOW	
71	MALE RUN TEE	
72	MALE BRANCH TEE	
77	FEMALE BRANCH TEE	
79	UNEQUAL UNION TEE	
82	BULKHEAD UNION	

# DOT PUSH TO CONNECT FITTINGS

# 545462



## 45 DEG MALE ELBOW DQ54DOT

Imperial tube to NPTF male pipe thread

PART #	TUBE	NPTF THREAD
DQ54DOT0402	1/4	1/8
DQ54DOT0404	1/4	1/4
DQ54DOT0406	1/4	3/8
DQ54DOT0602	3/8	1/8
DQ54DOT0604	3/8	1/4
DQ54DOT0606	3/8	3/8
DQ54DOT0608	3/8	1/2
DQ54DOT0804	1/2	1/4
DQ54DOT0806	1/2	3/8
DQ54DOT1006	5/8	3/8
DQ54DOT1008	5/8	1/2



## 45 DEG SWIVEL MALE ELBOW DQ54DOTS

Imperial tube to NPTF male pipe thread

PART #	TUBE	NPTF THREAD
DQ54DOTS0402	1/4	1/8
DQ54DOTS0404	1/4	1/4
DQ54DOTS0602	3/8	1/8
DQ54DOTS0604	3/8	1/4
DQ54DOTS0606	3/8	3/8
DQ54DOTS0804	1/2	1/4
DQ54DOTS0806	1/2	3/8
DQ54DOTS0808	1/2	1/2
DQ54DOTS1008	5/8	1/2
DQ54DOTS1208	3/4	1/2



## UNION - JOINER DQ62DOT

Imperial tube

PART #	IMPERIAL TUBE
DQ62DOT5/32	5/32
DQ62DOT03	3/16
DQ62DOT04	1/4
DQ62DOT06	3/8
DQ62DOT08	1/2
DQ62DOT10	5/8
DQ62DOT06M10/7	3/8 X 10/7

Non - DOT

DQ62P02	1/8
---------	-----

## UNION - JOINER MDQ62DOT

Metric tube

PART #	METRIC TUBE
MDQ62DOT4	4mm
MDQ62DOT6	6mm
MDQ62DOT8	8mm
MDQ62DOT9	9mm
MDQ62DOT10	10mm
MDQ62DOT11	11mm
MDQ62DOT12	12mm
MDQ62DOT15	15mm
MDQ62DOT16	16mm

# DOT PUSH TO CONNECT FITTINGS

# 646566



## UNION TEE DQ64DOT

Imperial tube

PART #	IMPERIAL TUBE
DQ64DOT5/32	5/32
DQ64DOT03	3/16
DQ64DOT04	1/4
DQ64DOT05	5/16
DQ64DOT06	3/8
DQ64DOT08	1/2
DQ64DOT10	5/8

## UNION TEE MDQ64DOT

Metric tube

PART #	METRIC TUBE
MDQ64DOT4	4mm
MDQ64DOT6	6mm
MDQ64DOT8	8mm
MDQ64DOT10	10mm
MDQ64DOT12	12mm



## UNION ELBOW DQ65DOT

Imperial tube

PART #	IMPERIAL TUBE
DQ65DOT5/32	5/32
DQ65DOT04	1/4
DQ65DOT06	3/8
DQ65DOT08	1/2

## UNION ELBOW MDQ65DOT

Metric tube

PART #	METRIC TUBE
MDQ65DOT6	6mm
MDQ65DOT8	8mm
MDQ65DOT10	10mm
MDQ65DOT12	12mm



## FEMALE CONNECTOR DQ66DOT

Imperial tube to NPTF female pipe thread

PART #	TUBE	NPTF THREAD
DQ66DOT0302	3/16	1/8
DQ66DOT0402	1/4	1/8
DQ66DOT0404	1/4	1/4
DQ66DOT0604	3/8	1/4
DQ66DOT0606	3/8	3/8
DQ66DOT0608	3/8	1/2
DQ66DOT0804	1/2	1/4
DQ66DOT0806	1/2	3/8
DQ66DOT0808	1/2	1/2

# DOT PUSH TO CONNECT FITTINGS

# 686868



## MALE CONNECTOR DQ68DOT

Imperial tube to NPTF male pipe thread

PART #	TUBE	NPTF THREAD
DQ68DOT5/3202	5/32	1/8
DQ68DOT0302	3/16	1/8
DQ68DOT0402	1/4	1/8
DQ68DOT0404	1/4	1/4
DQ68DOT0406	1/4	3/8
DQ68DOT0408	1/4	1/2
DQ68DOT0602	3/8	1/8
DQ68DOT0604	3/8	1/4
DQ68DOT0606	3/8	3/8
DQ68DOT0608	3/8	1/2
DQ68DOT0612	3/8	3/4
DQ68DOT0804	1/2	1/4
DQ68DOT0806	1/2	3/8
DQ68DOT0808	1/2	1/2
DQ68DOT1006	5/8	3/8
DQ68DOT1008	5/8	1/2
DQ68DOT1012	5/8	3/4
DQ68DOT1208	3/4	1/2
DQ68DOT1212	3/4	3/4

## BSPT MALE CONNECTOR DQ68DOT

Imperial tube to BSPT male pipe thread

PART #	TUBE	BSPT THREAD
DQ68DOT0402RK	1/4	1/8

## BSPT MALE CONNECTOR - NON DOT DQ68

Imperial tube to BSPT male pipe thread

PART #	TUBE	BSPT THREAD
DQ68P0602RK	3/8	1/8

## BSPT MALE CONNECTOR (ISUZU & HINO) MDQ68DOT

Metric tube to BSPT male pipe thread

PART #	TUBE	BSPT THREAD
MDQ68DOT604RK	6mm	1/4
MDQ68DOT806RK	8mm	3/8
MDQ68DOT808RK	8mm	1/2
MDQ68DOT1004RK	10mm	1/4
MDQ68DOT1206RK	12mm	3/8
MDQ68DOT1208RK	12mm	1/2

## MALE CONNECTOR MDQ68DOT

Metric tube to NPTF male pipe thread

PART #	TUBE	NPTF THREAD
MDQ68DOT602	6mm	1/8
MDQ68DOT604	6mm	1/4
MDQ68DOT606	6mm	3/8
MDQ68DOT608	6mm	1/2
MDQ68DOT802	8mm	1/8
MDQ68DOT804	8mm	1/4
MDQ68DOT806	8mm	3/8
MDQ68DOT1004	10mm	1/4
MDQ68DOT1006	10mm	3/8
MDQ68DOT1008	10mm	1/2
MDQ68DOT1204	12mm	1/4
MDQ68DOT1206	12mm	3/8
MDQ68DOT1208	12mm	1/2

# DOT PUSH TO CONNECT FITTINGS

# 686869



## MALE CONNECTOR DQ68DOT

Imperial tube to metric thread

PART #	TUBE	METRIC THREAD
DQ68DOT04M12	1/4	M12
DQ68DOT06M12	3/8	M12
DQ68DOT06M14	3/8	M14
DQ68DOT06M16	3/8	M16
DQ68DOT06M22	3/8	M22
DQ68DOT08M16	1/2	M16
DQ68DOT08M22	1/2	M22
DQ68DOT10M16	5/8	M16

## MALE CONNECTOR MDQ68DOT

Metric tube to metric thread

PART #	TUBE	METRIC THREAD
MDQ68DOT6M10	6mm	M10
MDQ68DOT6M12	6mm	M12
MDQ68DOT6M14	6mm	M14
MDQ68DOT6M16	6mm	M16
MDQ68DOT6M22	6mm	M22
MDQ68DOT8M10	8mm	M10
MDQ68DOT8M12	8mm	M12
MDQ68DOT8M14	8mm	M14
MDQ68DOT8M16	8mm	M16
MDQ68DOT8M22	8mm	M22
MDQ68DOT10M10	10mm	M10
MDQ68DOT10M12	10mm	M12
MDQ68DOT10M14	10mm	M14
MDQ68DOT10M16	10mm	M16
MDQ68DOT10M22	10mm	M22
MDQ68DOT12M12	12mm	M12
MDQ68DOT12M14	12mm	M14
MDQ68DOT12M16	12mm	M16
MDQ68DOT12M22	12mm	M22
MDQ68DOT16M16	16mm	M16
MDQ68DOT16M22	16mm	M22



## 90 DEG MALE ELBOW DQ69DOT

Imperial tube to NPTF male pipe thread

PART #	TUBE	NPTF THREAD
DQ69DOT5/3202	5/32	1/8
DQ69DOT0302	3/16	1/8
DQ69DOT0304	3/16	1/4
DQ69DOT0402	1/4	1/8
DQ69DOT0404	1/4	1/4
DQ69DOT0406	1/4	3/8
DQ69DOT0602	3/8	1/8
DQ69DOT0604	3/8	1/4
DQ69DOT0606	3/8	3/8
DQ69DOT0608	3/8	1/2
DQ69DOT0804	1/2	1/4
DQ69DOT0806	1/2	3/8
DQ69DOT0808	1/2	1/2
DQ69DOT1006	5/8	3/8
DQ69DOT1008	5/8	1/2
DQ69DOT1208	3/4	1/2

# DOT PUSH TO CONNECT FITTINGS

# 696969



## 90 DEG MALE ELBOW (SUZU & HINO) MDQ69DOT

Metric tube to BSPT male pipe thread

PART #	TUBE	BSPT THREAD
MDQ69DOT604RK	6mm	1/4
MDQ69DOT804RK	8mm	1/4
MDQ69DOT806RK	8mm	3/8
MDQ69DOT808RK	8mm	1/2
MDQ69DOT1004RK	10mm	1/4
MDQ69DOT1206RK	12mm	3/8
MDQ69DOT1208RK	12mm	1/2

## 90 DEG MALE ELBOW MDQ69DOT

Metric tube to NPT male pipe thread

PART #	TUBE	NPT THREAD
MDQ69DOT1004	10mm	1/4
MDQ69DOT1206	12mm	3/8



## 90 DEG SWIVEL MALE ELBOW DQ69DOTS

Imperial tube to NPTF male pipe thread

PART #	TUBE	NPTF THREAD
DQ69DOTS5/3202	5/32	1/8
DQ69DOTS0302	3/16	1/8
DQ69DOTS0304	3/16	1/4
DQ69DOTS0402	1/4	1/8
DQ69DOTS0404	1/4	1/4
DQ69DOTS0406	1/4	3/8
DQ69DOTS0408	1/4	1/2
DQ69DOTS0602	3/8	1/8
DQ69DOTS0604	3/8	1/4
DQ69DOTS0606	3/8	3/8
DQ69DOTS0608	3/8	1/2
DQ69DOTS0804	1/2	1/4
DQ69DOTS0806	1/2	3/8
DQ69DOTS0808	1/2	1/2
DQ69DOTS1006	5/8	3/8
DQ69DOTS1008	5/8	1/2
DQ69DOTS1012	5/8	3/4
DQ69DOTS1208	3/4	1/2
DQ69DOTS1212	3/4	3/4

## 90 DEG SWIVEL MALE ELBOW DQ69DOTS

Imperial tube to BSPT male pipe thread

PART #	TUBE	BSPT THREAD
DQ69DOTS0402RK	1/4	1/8
DQ69DOTS0602RK	3/8	1/8

## 90 DEG SWIVEL MALE ELBOW - NON DOT DQ69DOTS

Imperial tube to BSPT male pipe thread

PART #	TUBE	BSPT THREAD
DQ69PS0602RK	3/8	1/8

# DOT PUSH TO CONNECT FITTINGS

# 696969



## 90 DEG SWIVEL MALE ELBOW MDQ69DOTS

Metric tube to NPTF male pipe thread

PART #	TUBE	NPTF THREAD
MDQ69DOTS602	6mm	1/8
MDQ69DOTS604	6mm	1/4
MDQ69DOTS606	6mm	3/8
MDQ69DOTS608	6mm	1/2
MDQ69DOTS802	8mm	1/8
MDQ69DOTS804	8mm	1/4
MDQ69DOTS806	8mm	3/8
MDQ69DOTS808	8mm	1/2
MDQ69DOTS1004	10mm	1/4
MDQ69DOTS1006	10mm	3/8
MDQ69DOTS1204	12mm	1/4
MDQ69DOTS1206	12mm	3/8
MDQ69DOTS1208	12mm	1/2



## 90 DEG SWIVEL MALE ELBOW MDQ69DOTS

Metric tube to metric thread

PART #	TUBE	METRIC THREAD
MDQ69DOTS6M10	6mm	M10
MDQ69DOTS6M12	6mm	M12
MDQ69DOTS6M16	6mm	M16
MDQ69DOTS6M18	6mm	M18
MDQ69DOTS6M22	6mm	M22
MDQ69DOTS8M12	8mm	M12
MDQ69DOTS8M16	8mm	M16
MDQ69DOTS8M22	8mm	M22
MDQ69DOTS10M12	10mm	M12
MDQ69DOTS10M16	10mm	M16
MDQ69DOTS10M22	10mm	M22
MDQ69DOTS12M12	12mm	M12
MDQ69DOTS12M16	12mm	M16
MDQ69DOTS12M22	12mm	M22
MDQ69DOTS16M22	16mm	M22

## 90 DEG SWIVEL MALE ELBOW DQ69DOTS

Imperial tube to metric thread

PART #	TUBE	METRIC THREAD
DQ69DOTS04M12	1/4	M12
DQ69DOTS06M12	3/8	M12
DQ69DOTS06M14	3/8	M14
DQ69DOTS06M16	3/8	M16
DQ69DOTS06M22	3/8	M22
DQ69DOTS08M16	1/2	M16
DQ69DOTS08M22	1/2	M22
DQ69DOTS10M16	5/8	M16

# DOT PUSH TO CONNECT FITTINGS

# 707071



## 90 DEG FEMALE ELBOW DQ70DOT

Imperial tube to NPTF female pipe thread

PART #	TUBE	NPTF THREAD
DQ70DOT0402	1/4	1/8
DQ70DOT0404	1/4	1/4
DQ70DOT0604	3/8	1/4
DQ70DOT0606	3/8	3/8
DQ70DOT0806	1/2	3/8
DQ70DOT0808	1/2	1/2



## MALE RUN TEE DQ71DOT

Imperial tube to NPTF male pipe thread

PART #	TUBE	NPTF THREAD
DQ71DOT0402	1/4	1/8
DQ71DOT0404	1/4	1/4
DQ71DOT0604	3/8	1/4
DQ71DOT0606	3/8	3/8
DQ71DOT0806	1/2	3/8



## SWIVEL MALE RUN TEE DQ71DOTS

Imperial tube to NPTF male pipe thread

PART #	TUBE	NPTF THREAD
DQ71DOTS0402	1/4	1/8
DQ71DOTS0404	1/4	1/4
DQ71DOTS0604	3/8	1/4
DQ71DOTS0606	3/8	3/8
DQ71DOTS0804	1/2	1/4
DQ71DOTS0806	1/2	3/8
DQ71DOTS0808	1/2	1/2



## 90 DEG SWIVEL FEMALE ELBOW DQ70DOTS

Imperial tube to NPTF female pipe thread

PART #	TUBE	NPTF THREAD
DQ70DOTS0604	3/8	1/4



## SWIVEL MALE RUN TEE MDQ71DOTS

Metric tube to metric thread

PART #	TUBE	METRIC THREAD
MDQ71DOTS6M12	6mm	M12
MDQ71DOTS10M16	10mm	M16
MDQ71DOTS12M16	12mm	M16
MDQ71DOTS12M22	12mm	M22



# DOT PUSH TO CONNECT FITTINGS

# 727272



## MALE BRANCH TEE DQ72DOT

Imperial tube to NPTF male pipe thread

PART #	TUBE	NPTF THREAD
DQ72DOT0404	1/4	1/4
DQ72DOT0406	1/4	3/8
DQ72DOT0604	3/8	1/4
DQ72DOT0606	3/8	3/8
DQ72DOT0608	3/8	1/2
DQ72DOT0806	1/2	3/8
DQ72DOT0808	1/2	1/2



## SWIVEL MALE BRANCH TEE DQ72DOTS

Imperial tube to NPTF male pipe thread

PART #	TUBE	NPTF THREAD
DQ72DOTS0402	1/4	1/8
DQ72DOTS0404	1/4	1/4
DQ72DOTS0406	1/4	3/8
DQ72DOTS0602	3/8	1/8
DQ72DOTS0604	3/8	1/4
DQ72DOTS0606	3/8	3/8
DQ72DOTS0804	1/2	1/4
DQ72DOTS0806	1/2	3/8
DQ72DOTS0808	1/2	1/2

## SWIVEL MALE BRANCH TEE MDQ72DOTS

Metric tube to NPTF male pipe thread

PART #	TUBE	NPTF THREAD
MDQ72DOTS602	6mm	1/8
MDQ72DOTS604	6mm	1/4
MDQ72DOTS804	8mm	1/4
MDQ72DOTS1004	10mm	1/4
MDQ72DOTS1204	12mm	1/4



## SWIVEL MALE BRANCH TEE DQ72DOTS

Imperial tube to metric thread

PART #	TUBE	METRIC THREAD
DQ72DOTS06M22	3/8	M22
DQ72DOTS08M22	1/2	M22

## SWIVEL MALE BRANCH TEE MDQ72DOTS

Metric tube to metric thread

PART #	TUBE	METRIC THREAD
MDQ72DOTS6M12	6mm	M12
MDQ72DOTS10M16	10mm	M16
MDQ72DOTS12M16	12mm	M16
MDQ72DOTS12M22	12mm	M22

# DOT PUSH TO CONNECT FITTINGS

# 777982



### SWIVEL FEMALE BRANCH TEE DQ77DOTS

Imperial tube to NPTF female pipe thread

PART #	TUBE	NPTF THREAD
DQ77DOTS0604	3/8	1/4



### UNEQUAL UNION TEE DQ79DOT

Imperial tube

PART #	TUBE
DQ79DOT0604	3/8 X 1/4 X 3/8

### UNEQUAL UNION TEE DQ79DOT

Imperial / Metric / Imperial tube

PART #	TUBE
DQ79DOT06M8	3/8 X 8mm X 3/8
DQ79DOT08M8	1/2 X 8mm X 1/2

### UNEQUAL UNION TEE MDQ79DOT

Metric tube

PART #	TUBE
MDQ79DOT128	12 X 8 X 12mm

### UNEQUAL UNION TEE MDQ79DOT

Metric tube / Imperial tube / Metric tube

PART #	TUBE
MDQ79DOT1206	12 X 3/8 X 12mm



### BULKHEAD UNION DQ82DOT

Imperial tube

PART #	TUBE
DQ82DOT04	1/4
DQ82DOT06	3/8
DQ82DOT08	1/2

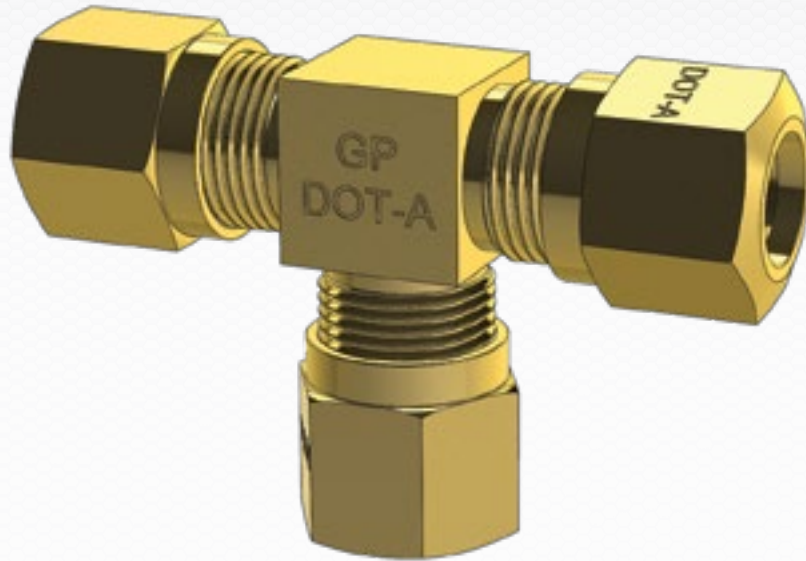

---

**CONFORMITY TO:**

AUSTRALIAN DESIGN RULES ADR-38/05

DOT FMVSS 571.106

SAE J246

SAE J1131

---

# COMPRESSION DOT FITTINGS

# 546264



## 45 DEG MALE ELBOW GP54CDOT

Imperial tube to NPTF male pipe thread

PART #	TUBE	NPTF THREAD
GP54CDOT0402	1/4	1/8
GP54CDOT0404	1/4	1/4
GP54CDOT0604	3/8	1/4
GP54CDOT0606	3/8	3/8
GP54CDOT0804	1/2	1/4
GP54CDOT0806	1/2	3/8
GP54CDOT0808	1/2	1/2



## UNION - JOINER GP62CDOT

Imperial tube

PART #	TUBE
GP62CDOT04	1/4
GP62CDOT06	3/8
GP62CDOT08	1/2
GP62CDOT10	5/8
GP62CDOT12	3/4

## UNION - JOINER GP-62C

Metric

PART #	COMPRESSION JOINER
GP62C-M4	4mm
GP62C-M6	6mm
GP62C-M8	8mm
GP62C-M10	10mm
GP62C-M12	12mm
GP62C-M16	16mm



## UNION TEE GP64CDOT

Imperial tube

PART #	TUBE
GP64CDOT04	1/4
GP64CDOT05	5/16
GP64CDOT06	3/8
GP64CDOT08	1/2

## UNION TEE GP-64C

Metric

PART #	COMPRESSION TEE JOINER
GP64C-M6	4mm
GP64C-M8	6mm
GP64C-M10	8mm
GP64C-M12	10mm

# COMPRESSION DOT FITTINGS

# 686971



## MALE CONNECTOR GP68CDOT

Imperial tube to NPTF male pipe thread

PART #	TUBE	NPTF THREAD
GP68CDOT0402	1/4	1/8
GP68CDOT0404	1/4	1/4
GP68CDOT0406	1/4	3/8
GP68CDOT0602	3/8	1/8
GP68CDOT0604	3/8	1/4
GP68CDOT0606	3/8	3/8
GP68CDOT0608	3/8	1/2
GP68CDOT0804	1/2	1/4
GP68CDOT0806	1/2	3/8
GP68CDOT0808	1/2	1/2
GP68CDOT1006	5/8	3/8
GP68CDOT1008	5/8	1/2
GP68CDOT1208	3/4	1/2

## STRAIGHT CONNECTORS GP-68C

Metric

PART #	TUBE	BSPT THREAD
GP68C-M602	6mm	1/8
GP68C-M804	8mm	1/4
GP68C-M1004	10mm	1/4
GP68C-M1204	12mm	1/4



## 90 DEG MALE ELBOW GP69CDOT

Imperial tube to NPTF male pipe thread

PART #	TUBE	NPTF THREAD
GP69CDOT0402	1/4	1/8
GP69CDOT0404	1/4	1/4
GP69CDOT0406	1/4	3/8
GP69CDOT0602	3/8	1/8
GP69CDOT0604	3/8	1/4
GP69CDOT0606	3/8	3/8
GP69CDOT0608	3/8	1/2
GP69CDOT0804	1/2	1/4
GP69CDOT0806	1/2	3/8
GP69CDOT0808	1/2	1/2
GP69CDOT1006	5/8	3/8
GP69CDOT1008	5/8	1/2

## ELBOWS GP-69C

Metric

PART #	TUBE	BSPT THREAD
GP69C-M602	6mm	1/8
GP69C-M804	8mm	1/4
GP69C-M1004	10mm	1/4
GP69C-M1204	12mm	1/4



## MALE RUN TEE GP71CDOT

Imperial tube to NPTF male pipe thread

PART #	TUBE	NPTF THREAD
GP71CDOT0402	1/4	1/8
GP71CDOT0604	3/8	1/4

# COMPRESSION DOT FITTINGS

# 72791460



## MALE BRANCH TEE GP72CDOT

Imperial tube to NPTF male pipe thread

PART #	TUBE	NPTF THREAD
GP72CDOT0402	1/4	1/8
GP72CDOT0404	1/4	1/4
GP72CDOT0604	3/8	1/4
GP72CDOT0606	3/8	3/8
GP72CDOT0804	1/2	1/4
GP72CDOT0806	1/2	3/8

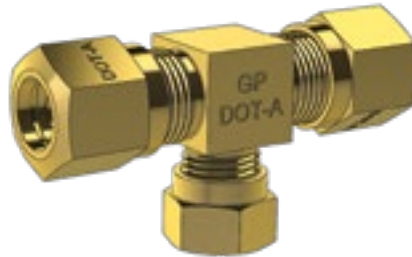

## UNEQUAL UNION TEE GP79CDOT

Imperial tube to NPTF male pipe thread

PART #	TUBE	NPTF THREAD
GP79CDOT0604	3/8 x 1/4	3/8
GP79CDOT0806	1/2 x 3/8	1/2



## NUT GP1461

Imperial tube

PART #	NUT
GP1461-04	1/4
GP1461-06	3/8
GP1461-08	1/2
GP1461-10	5/8

Metric tube

PART #	NUT
GP-1461-M4	4mm
GP-1461-M6	6mm
GP-1461-M8	8mm
GP-1461-M10	10mm
GP-1461-M12	12mm
GP-1461-M16	16mm



## OLIVE GP1460

Imperial tube

PART #	OLIVE
GP1460-04	1/4
GP1460-06	3/8
GP1460-08	1/2
GP1460-10	5/8
GP1460-12	3/4

Metric tube

PART #	OLIVE
GP-1460-M4	4mm
GP-1460-M6	6mm
GP-1460-M8	8mm
GP-1460-M10	10mm
GP-1460-M12	12mm
GP-1460-M16	16mm



## INSERT GP1484

Imperial tube

PART #	INSERT
GP1484-04	1/4
GP1484-06	3/8
GP1484-08	1/2
GP1484-10	5/8
GP1484-12	3/4

Metric tube

PART #	INSERT
GP-1484-M4	4mm
GP-1484-M6	6mm
GP-1484-M8	8mm
GP-1484-M10	10mm
GP-1484-M12	12mm
GP-1484-M16	16mm

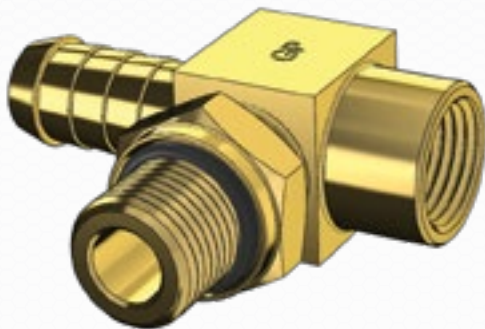

---

ALL BRASS FITTINGS ARE DESIGNED TO SUIT NORTH AMERICAN  
AND EUROPEAN TRUCK & TRAILER AIR BRAKE SYSTEMS

---

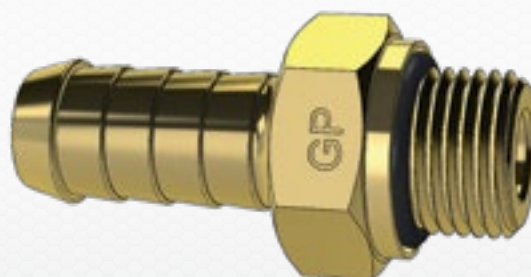



### HEX HEAD DRAIN COCK

#### XD-16

Imperial

PART #	DRAIN COCK
XD-16	1/4 NPT HEX HEAD DRAIN COCK



### WING NUT DRAIN COCKS

#### XD-16

Imperial

PART #	DRAIN COCK
XD-16-02W	1/8 NPT WING NUT DRAIN COCK
XD-16-04W	1/4 NPT WING NUT DRAIN COCK
XD-16-06W	3/8 NPT WING NUT DRAIN COCK
XD-16-08W	1/2 NPT WING NUT DRAIN COCK



### PULL CHORD DRAIN COCK

#### GP-XD

Imperial

PART #	DRAIN COCK
GP-XD-16	1/4 NPT PULL CHORD DRAIN COCK



### BALL VALVES MALE/FEMALE

#### GPBV-500

Imperial

PART #	VALVE
GPBV-500-01	1/2 M X 1/2 F NPSF 'T' HANDLE
GPBV-500-03	MINI BALL VALVE 1/4 M X 1/4 F BSP 'T' HANDLE
GPBV-500-05	3/8 M X 3/8 F BSP 'T' HANDLE
GPBV-500-06	1/4 M X 1/4 F BSP 'T' HANDLE
GPBV-500-07	MINI BALL VALVE 3/8 M X 3/8 F BSP 'T' HANDLE
GPBV-500-08	1/2 M X 1/2 F NPT LEVER HANDLE

Other sizes available upon request



### BALL VALVES FEMALE/FEMALE

#### GPBV-500

Imperial

PART #	VALVE
GPBV-500-02	1/2 F X 1/2 F NPTS 'T' HANDLE
GPBV-500-04	1/2 F X 1/2 F NPSF LEVER HANDLE
GPBV-500-09	3/8 F X 3/8 F BSP 'T' HANDLE
GPBV-500-10	1/4 F/F BSP 'T' HANDLE

Other sizes available upon request





## BRASS NUT GP-M

Metric

PART #	THREAD
GP-M16-NUT	16mm NUT
GP-M22-NUT	22mm NUT



## THRUST WASHERS GP-TW

Metric

PART #	SIZE
GP-TW-M12	12mm THRUST WASHER
GP-TW-M16	16mm THRUST WASHER
GP-TW-M22	22mm THRUST WASHER



## REDUCING BUSHES GP-024

Imperial

PART #	NPSF	NPT
GP-024-0204	1/8	1/4
GP-024-0206	1/8	3/8
GP-024-0208	1/8	1/2
GP-024-02012	1/8	3/4
GP-024-0406	1/4	3/8
GP-024-0408	1/4	1/2
GP-024-04012	1/4	3/4
GP-024-0608	3/8	1/2
GP-024-06012	3/8	3/4
GP-024-08012	1/2	3/4



## O-RING GP-TWOR

Metric

PART #	SIZE
GP-TWOR-M12	12mm THRUST WASHER O-RING
GP-TWOR-M16	16mm THRUST WASHER O-RING
GP-TWOR-M22	22mm THRUST WASHER O-RING

## REDUCING BUSHES GP-024

Metric

PART #	NPSF	NPT
GP-024-M16M22A	M16	M22



**90 DEG MALE - FEMALE ELBOW  
GP-025**

Imperial

PART #	NPSF	NPT
GP-025-02	1/8	1/8
GP-025-0402	1/4	1/8
GP-025-04	1/4	1/4
GP-025-0604	3/8	1/4
GP-025-06	3/8	3/8
GP-025-08	1/2	1/2
GP-025-012	3/4	3/4

**90 DEG MALE - FEMALE ELBOW  
GP-025S**

Metric

PART #	METRIC
GP-025S-M18	M18
GP-025S-M22A	M22



**SOCKET  
GP-026**

Imperial

PART #	NPSF
GP-026-02	1/8
GP-026-0402	1/4 x 1/8
GP-026-04	1/4
GP-026-0604	3/8 x 1/4
GP-026-06	3/8
GP-026-0806	1/2 x 3/8
GP-026-08	1/2
GP-026-012	3/4

**SOCKET  
GP-026**

Metric

PART #	METRIC
GP-026-M10	M10
GP-026-M12	M12
GP-026-M16	M16
GP-026-M22	M22



**HEX NIPPLE - IMPERIAL  
GP-027**

Imperial

PART #	NPT
GP-027-02	1/8
GP-027-04	1/4
GP-027-06	3/8
GP-027-08	1/2
GP-027-012	3/4

**STEEL HEX NIPPLE  
GP-027**

Imperial

PART #	NPT
GP-027-04B	1/4
GP-027-08B	1/2
GP-027-012B	3/4



**HEX NIPPLE**  
**GP-027**

Metric - Includes nut, thrust washers & o-rings

PART #	METRIC
GP-027-M22A	M22

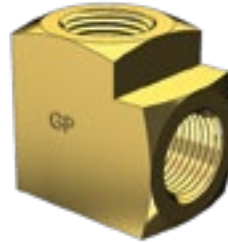

**90 DEG FEMALE ELBOW**  
**GP-034**

Imperial

PART #	NPSF
GP-034-02	1/8
GP-034-04	1/4
GP-034-06	3/8
GP-034-08	1/2
GP-034-012	3/4



**FEMALE TEE**  
**GP-035**

Imperial

PART #	NPSF
GP-035-02	1/8
GP-035-04	1/4
GP-035-06	3/8
GP-035-08	1/2
GP-035-12	3/4

**FEMALE TEE**  
**GP-035**

Metric

PART #	METRIC
GP-035-M16	M16
GP-035-M22	M22



### 90 DEG MALE ELBOW

#### GP-048

Imperial

PART #	NPT
GP-048-02	1/8
GP-048-04	1/4
GP-048-0604	3/8 X 1/4
GP-048-06	3/8
GP-048-08	1/2



### PLUG HEX

#### GP-064

Metric includes thrust washer o-ring

PART #	METRIC
GP-064-M12A	M12
GP-064-M14A	M14
GP-064-M16A	M16
GP-064-M22A	M22

M14 comes with aluminium washer



### PLUG HEX

#### GP-064

Imperial

PART #	NPT
GP-064-02	1/8
GP-064-04	1/4
GP-064-06	3/8
GP-064-08	1/2
GP-064-012	3/4
GP-064-016	1"



### PLUG HEX - STEEL

#### GP-064B

Imperial

PART #	NPT
GP-064-04B	1/4
GP-064-06B	3/8
GP-064-08B	1/2
GP-064-012B	3/4



### ADAPTOR - BRASS GP-072

Imperial to Imperial

PART #	NPSF	NPT
GP-072-0202	1/8	1/8
GP-072-0402	1/4	1/8
GP-072-0404	1/4	1/4
GP-072-0602	3/8	1/8
GP-072-0604	3/8	1/4
GP-072-0606	3/8	3/8
GP-072-0804	1/2	1/4
GP-072-0806	1/2	3/8
GP-072-0808	1/2	1/2
GP-072-01208	3/4	1/2



### ADAPTOR - STEEL GP-072

Imperial to Imperial

PART #	NPSF	NPT
GP-072-0804B	1/2	1/4



### ADAPTOR - BRASS GP-072

Imperial female to metric male

PART #	NPSF	METRIC
GP-072-04M12A	1/4	M12
GP-072-04M14A	1/4	M14
GP-072-04M16A	1/4	M16
GP-072-04M22A	1/4	M22
GP-072-06M16A	3/8	M16
GP-072-06M22A	3/8	M22
GP-072-08M22A	1/2	M22
GP-072-08M26	1/2	M26X1.5



### ADAPTOR - STEEL GP-072

Imperial female to metric male

PART #	NPSF	METRIC
GP-072-06M16AB	3/8	M16
GP-072-08M16AB	1/2	M16
M14 comes with aluminium washer		



### ADAPTOR - BRASS GP-072

Metric female to imperial male

PART #	METRIC	NPT
GP-072-M1604	M16	1/4
GP-072-M1606	M16	3/8
GP-072-M1608	M16	1/2
GP-072-M1808	M18	1/2
GP-072-M22F012	M22	3/4



### ADAPTOR - STEEL GP-072

Metric female to imperial male

PART #	METRIC	NPT
GP-072-M1604B	M16	1/4
GP-072-M1608B	M16	1/2
GP-072-M2208B	M22	1/2



**UNEQUAL HEX NIPPLE  
GP-073**

Imperial

PART #	NPT	NPT
GP-073-0402	1/4	1/8
GP-073-0602	3/8	1/8
GP-073-0604	3/8	1/4
GP-073-0608	3/8	1/2
GP-073-0804	1/2	1/4
GP-073-01204	3/4	1/4
GP-073-01206	3/4	3/8
GP-073-01208	3/4	1/2

Metric

PART #	NPT	METRIC
GP-073-04M12A	1/4	M12
GP-073-04M16A	1/4	M16
GP-073-06M16A	3/8	M16
GP-073-06M22A	3/8	M22
GP-073-012M22A	3/4	M22
GP-073-M16M22A	M16	M22

Steel

PART #	NPT	NPT
GP-073-0604B	3/8	1/4
GP-073-01208B	3/4	1/2



**MALE - FEMALE  
BULKHEAD CONNECTORS  
GP-082** Imperial

PART #	NPT	NPSF	BSPP
GP-082-08012B	1/2	1/2	3/4



**FEMALE - FEMALE PANEL  
MOUNT BULKHEAD CONNECTORS  
GP-082**

Imperial

PART #	NPSF	BSPP
GP-082-0408B	1/4	1/2
GP-082-06016	3/8	1"
GP-082-08012F	1/2	3/4



**45 DEG MALE FEMALE ELBOW  
GP-425**

Imperial

PART #	NPSF	NPT
GP-425-02	1/8	1/8
GP-425-04	1/4	1/4
GP-425-06	3/8	3/8
GP-425-08	1/2	1/2
GP-425-012	3/4	3/4



**45 DEG MALE - FEMALE  
SWIVEL ELBOW  
GP-425S**

Imperial

PART #	NPSF	NPT
GP-425S-04	1/4	1/4

# BRASS FITTINGS

# 434450570

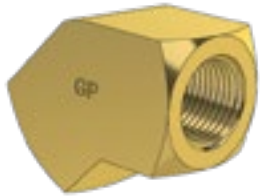

**45 DEG FEMALE ELBOW  
GP-434**

Imperial

PART #	NPSF
GP-434-02	1/8
GP-434-04	1/4
GP-434-06	3/8



**45 DEG HOSE BARB  
GP-450**

Imperial

PART #	HOSE	NPT
GP-450-0806	1/2	3/8



**HOSE BARB - IMPERIAL THREADS  
GP-570**

Imperial

PART #	HOSE	NPT
GP-570-0402	1/4	1/8
GP-570-0404	1/4	1/4
GP-570-0406	1/4	3/8
GP-570-0604	3/8	1/4
GP-570-0606	3/8	3/8
GP-570-0608	3/8	1/2
GP-570-0802	1/2	1/8
GP-570-0804	1/2	1/4
GP-570-0806	1/2	3/8
GP-570-0808	1/2	1/2
GP-570-08012	1/2	3/4
GP-570-01004	5/8	1/4
GP-570-01006	5/8	3/8
GP-570-01008	5/8	1/2
GP-570-010012	5/8	3/4
GP-570-01208	3/4	1/2
GP-570-012	3/4	3/4
GP-570-012016	3/4	1"



**HOSE BARBS - METRIC THREADS  
GP-570**

Imperial to Metric includes thrust washer

PART #	HOSE	METRIC
GP-570-08M16A	1/2	M16
GP-570-08M22A	1/2	M22
GP-570-012M22A	3/4	M22



**HOSE BARB MALE RUN TEE**  
**GP-571**

Imperial

PART #	HOSE	HOSE	NPT
GP-571-080806	1/2	1/2	3/8



**HOSE BARB TEE**  
**GP-573**

Imperial

PART #	HOSE
GP-573-02	1/8
GP-573-03	3/16
GP-573-04	1/4
GP-573-05	5/16
GP-573-06	3/8
GP-573-08	1/2



**HOSE BARB JOINER**  
**GP-574**

Imperial

PART #	HOSE
GP-574-02	1/8
GP-574-03	3/16
GP-574-04	1/4
GP-574-05	5/16
GP-574-06	3/8
GP-574-08	1/2
GP-574-010	5/8
GP-574-012	3/4



**HOSE BARB BRANCH TEE**  
**GP-575**

Imperial / Metric

PART #	HOSE	MALE & NUT	FEM
GP-575-08M16M16F	1/2	M16	M16



**HOSE BARB FEMALE RUN TEE**  
**GP-576**

Imperial / Metric

PART #	HOSE	FEMALE	NPT
GP-576-08M16F06	1/2	M16	3/8



**90 DEG HOSE BARB**  
**GP-579**

Imperial

PART #	HOSE	NPT
GP-579-0402	1/4	1/8
GP-579-0602	3/8	1/8
GP-579-0604	3/8	1/4
GP-579-0606	3/8	3/8
GP-579-0608	3/8	1/2
GP-579-0806	1/2	3/8
GP-579-0808	1/2	1/2
GP-579-01006	5/8	3/8
GP-579-01008	5/8	1/2
GP-579-01208	3/4	1/2
GP-579-012	3/4	3/4



**90 DEG HOSE BARB**  
**GP-579**

Metric includes nut, thrust washer & o-ring

PART #	HOSE	MALE & NUT
GP-579-08M16A	1/2	M16





**REGULATING SILENCER  
GP-672**

Imperial

PART #	BSP
GP-672-04	1/4



**COMPACT SILENCER  
GP-673**

Imperial

PART #	BSP
GP-673-02	1/8
GP-673-04	1/4



**PLASTIC SILENCER  
GP-673**

Imperial

PART #	BSP
GP-673-04P	1/4



**TEE - MALE RUN TEE  
GP-702**

Imperial

PART #	NPSF	NPSF	NPT
GP-702-02	1/8	1/8	1/8
GP-702-04	1/4	1/4	1/4
GP-702-06	3/8	3/8	3/8
GP-702-08	1/2	1/2	1/2



**TEE - MALE BRANCH TEE  
GP-735**

Imperial

PART #	NPSF	NPT	NPSF
GP-735-02	1/8	1/8	1/8
GP-735-04	1/4	1/4	1/4
GP-735-06	3/8	3/8	3/8
GP-735-08	1/2	1/2	1/2



**TEST POINT  
GP-3405**

Imperial

PART #	NPTF
GP-3405-06	3/8



**TEST POINT  
GP-3405**

Metric

PART #	METRIC
GP-3405-M16A	M16

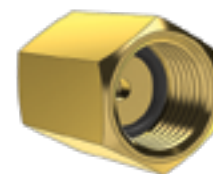

**TEST POINT COUPLING  
GP-3406**

Imperial / Metric

PART #	FEMALE	FEMALE
GP-3406-04M16	1/4	M16



# COMPOSITE FITTINGS

## TRUCK/TRAILER



---

DESIGNED, MANUFACTURED & CONFORMS TO:

AUSTRALIAN DESIGN RULES ADR-38/05

AUSTRALIAN STANDARDS AS4001.3-2003

---

# COMPOSITE FITTINGS

# 62646588



## UNION - JOINER GP62P

Imperial

PART #	TUBE
GP62P02	1/8
GP62P5/32	5/32
GP62P03	3/16
GP62P04	1/4
GP62P05	5/16
GP62P06	3/8
GP62P08	1/2

## UNION - JOINER GPM62P

Metric

PART #	TUBE
GPM62P4	4mm
GPM62P6	6mm
GPM62P8	8mm
GPM62P10	10mm
GPM62P12	12mm
GPM62P16	16mm



## UNION TEE GP64P

Imperial

PART #	TUBE
GP64P04	1/4
GP64P06	3/8
GP64P08	1/2

## UNION TEE GPM64P

Metric

PART #	TUBE
GPM64P6	6mm
GPM64P8	8mm
GPM64P10	10mm
GPM64P12	12mm



## UNION ELBOW GP65P

Imperial

PART #	TUBE
GP65P04	1/4
GP65P06	3/8
GP65P08	1/2

## UNION ELBOW GPM65P

Metric

PART #	TUBE
GPM65P4	4mm
GPM65P6	6mm
GPM65P8	8mm
GPM65P10	10mm
GPM65P12	12mm



## Y UNION - JOINER GP88P

Imperial

PART #	TUBE
GP88P0404	1/4
GP88P0606	3/8

## Y UNION - JOINER GPM88P

Metric

PART #	TUBE
GPM88P4	4mm
GPM88P6	6mm
GPM88P8	8mm
GPM88P10	10mm
GPM88P12	12mm

# COMPOSITE FITTINGS

# 686972



## MALE CONNECTOR GP68P

Imperial

PART #	TUBE	BSPT THREAD
GP68P0202	1/8	1/8
GP68P0302	3/16	1/8
GP68P0402	1/4	1/8
GP68P0404	1/4	1/4
GP68P0406	1/4	3/8
GP68P0604	3/8	1/4
GP68P0606	3/8	3/8
GP68P0608	3/8	1/2
GP68P0804	1/2	1/4
GP68P0806	1/2	3/8

## MALE CONNECTOR GPM68P

Metric

PART #	TUBE	BSPT THREAD
GPM68P402	4mm	1/8
GPM68P404	4mm	1/4
GPM68P602	6mm	1/8
GPM68P604	6mm	1/4
GPM68P606	6mm	3/8
GPM68P802	8mm	1/8
GPM68P804	8mm	1/4
GPM68P806	8mm	3/8
GPM68P1002	10mm	1/8
GPM68P1004	10mm	1/4
GPM68P1006	10m	3/8
GPM68P1008	10mm	1/2
GPM68P1204	12mm	1/4
GPM68P1206	12mm	3/8
GPM68P1208	12mm	1/2



## MALE ELBOW GP69P

Imperial

PART #	TUBE	BSPT THREAD
GP69P0402	1/4	1/8
GP69P0404	1/4	1/4
GP69P0406	1/4	3/8
GP69P0502	5/16	1/8
GP69P0504	5/16	1/4
GP69P0602	3/8	1/8
GP69P0604	3/8	1/4
GP69P0606	3/8	3/8
GP69P0608	3/8	1/2
GP69P0804	1/2	1/4
GP69P0806	1/2	3/8

## MALE ELBOW GPM69P

Metric

PART #	TUBE	BSPT THREAD
GPM69P404	4mm	1/4
GPM69P602	6mm	1/8
GPM69P604	6mm	1/4
GPM69P606	6mm	3/8
GPM69P802	8mm	1/8
GPM69P804	8mm	1/4
GPM69P806	8mm	3/8
GPM69P1004	10mm	1/4



## MALE BRANCH TEE GP72P

Imperial

PART #	TUBE	BSPT TREAD
GP72P0402	1/4	1/8
GP72P0404	1/4	1/4
GP72P0406	1/4	3/8
GP72P0604	3/8	1/4
GP72P0606	3/8	1/4

## MALE BRANCH TEE GPM72P

Metric

PART #	TUBE	BSPT THREAD
GPM72P602	6mm	1/8
GPM72P604	6mm	1/4
GPM72P802	8mm	1/8
GPM72P804	8mm	1/4
GPM72P806	8mm	3/8
GPM72P1004	10mm	1/4
GPM72P1006	10mm	3/8
GPM72P1008	10mm	1/2
GPM72P1204	12mm	1/4
GPM72P1206	12mm	3/8
GPM72P1208	12mm	1/2



# AIR COUPLINGS TRUCK/TRAILER

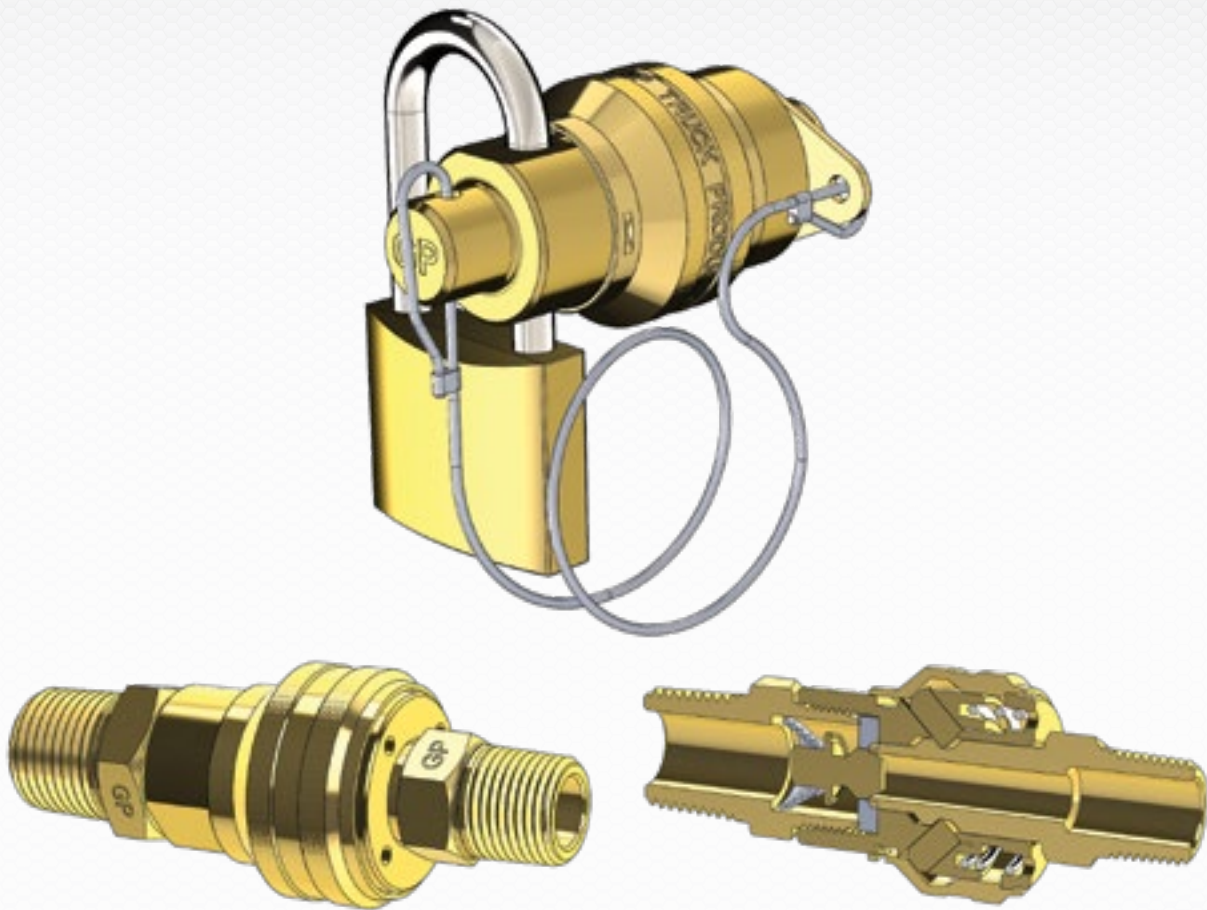

---

DESIGNED, MANUFACTURED & CONFORMS TO:

AUSTRALIAN DESIGN RULES ADR-38/05

AUSTRALIAN STANDARDS AS4001.3-2003

---

# COUPLING & ADAPTORS

# 920930935

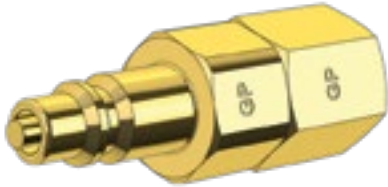

## FEMALE ADAPTOR - SEALING GP-920

Imperial

PART #	X-REF	NPSF
GP-920-04	CA93-88	1/4
GP-920-06	CA93-89	3/8
GP-920-08	CA93-90	1/2



## MALE ADAPTOR - SEALING GP-930

Imperial

PART #	X-REF	NPT
GP-930-04	CA93-91	1/4
GP-930-06	CA93-92	3/8
GP-930-08	CA93-93	1/2



## HOSE BARB ADAPTORS GP-935

Imperial

PART #	X-REF	HOSE
GP-935-06	CA93-8	3/8
GP-935-08	CA93-14	1/2



## FEMALE ADAPTOR - NON SEALING GP-921

Imperial

PART #	X-REF	NPSF
GP-921-04	CA93-21	1/4
GP-921-06	CA93-22	3/8
GP-921-08	CA93-23	1/2



## MALE ADAPTOR - NON SEALING GP-931

Imperial

PART #	X-REF	NPT
GP-931-04	CA93-18	1/4
GP-931-06	CA93-19	3/8
GP-931-08	CA93-20	1/2



## TRAILER COUPLING LOCK GP-936, GP-937, GP-938

Padlock included

PART #	TO SUIT
GP-936-CLM	To suit Male threaded adaptor GP-931-08
GP-936-CLF	To suit Female threaded adaptor GP-921-08
GP-937-CLM	Supplied without the padlock, to suit Male threaded adaptor GP-931-08
GP-937-CLF	Supplied without the padlock, to suit Female threaded adaptor GP-921-08
GP-938-CLMKA	Keyed alike padlock, to suit Male threaded adaptor GP-931-08
GP-938-CLFKA	Keyed alike padlock, to suit Female threaded adaptor GP-921-08

# COUPLING & ADAPTORS

# 94095093



## FEMALE COUPLING - SEALING GP-940

Imperial

PART #	X-REF	NPSF
GP-940-04	CA93-33	1/4
GP-940-06	CA93-34	3/8
GP-940-08	CA93-35	1/2



## MALE COUPLING - SEALING GP-950

Imperial

PART #	X-REF	NPT
GP-950-04	CA93-30	1/4
GP-950-06	CA93-31	3/8
GP-950-08	CA93-32	1/2

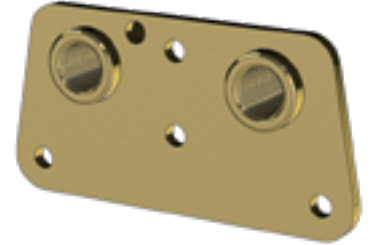

## COUPLING ADAPTOR PLATE GP-93

Imperial

PART #	X-REF	NPSF
GP-93-A420	SB420	1/2 PORTS



## FEMALE COUPLING - NON SEALING GP-941

Imperial

PART #	X-REF	NPSF
GP-941-04	CA93-86	1/4
GP-941-06	CA93-82	3/8
GP-941-08	CA93-87	1/2



## MALE COUPLING - NON SEALING GP-951

Imperial

PART #	X-REF	NPT
GP-951-04	CA93-83	1/4
GP-951-06	CA93-84	3/8
GP-951-08	CA93-85	1/2



## COUPLING DUST COVER GP-93

Insert into couplings - Imperial

PART #	COUPLING DUST COVER
GP-93-79	DOMED WITH CHAIN

# COUPLING & ADAPTORS

# 939393



## ADAPTOR DUST COVER

**GP-93**

Place over adaptors

PART #	ADAPTOR DUST COVER
GP-93-81	WITH CHAIN



## ADAPTOR DEAD END

**GP-93**

Seals the coupling

PART #	ADAPTOR DEAD END
GP-93-99	DEAD END INC. WASHER, SPRING WASHER & NUT



## BULKHEAD ADAPTOR

**GP-93**

includes ferrule & nut

PART #	BULKHEAD ADAPTOR
GP-93-109A	NON SEAL 3/8 TUBE X 1/2 BSPP MALE BULKHEAD ADAPTOR



## ADAPTOR DUST COVER

**GP-93**

Place over adaptors

PART #	ADAPTOR DUST COVER
GP-93-97	WITH NUT & BOLT



## BULKHEAD COUPLING - NON SEAL

**GP-93**

includes ferrule & nut

PART #	
GP-93-112A	NON SEAL 3/8 TUBE X 1/2 BSPP MALE BULKHEAD COUPLING



## BULKHEAD COUPLING - SEALING

**GP-93**

includes ferrule & nut

PART #	
GP-93-117A	SEALING 3/8 TUBE X 1/2 BSPP MALE BULKHEAD COUPLING





# WORKSHOP AIRLINE COUPLINGS & ADAPTORS



# WORKSHOP AIRLINE COUPLINGS & ADAPTORS

# 618192



## FEMALE COUPLING ADAPTOR GP-961

Female

PART #	X-REF	NPSF
GP-961-04	20PF	1/4
GP-961-06	30PF	3/8
GP-961-08	40PF	1/2



## MALE COUPLING ADAPTOR GP-971

Male

PART #	X-REF	NPT
GP-971-04	20PM	1/4
GP-971-06	30PM	3/8
GP-971-08	40PM	1/2



## HOSEBARB COUPLING ADAPTOR GP-972

Hosebarb

PART #	X-REF	HOSE
GP-972-04	20PH	1/4
GP-972-06	30PH	3/8
GP-972-08	40PH	1/2



## FEMALE COUPLING SEALING GP-981

Female

PART #	X-REF	NPSF
GP-981-04	20SF	1/4
GP-981-06	30SF	3/8
GP-981-08	40SF	1/2



## MALE COUPLING SEALING GP-991

Male

PART #	X-REF	NPT
GP-991-04	20SM	1/4
GP-991-06	30SM	3/8
GP-991-08	40SM	1/2



## COUPLING HOSEBARB GP-992

Hosebarb

PART #	X-REF	NPT
GP-992-06	30SH	3/8
GP-992-08	40SH	1/2

TAKE FULL ADVANTAGE OF THE YOUR RETAIL SPACE WITH THE GP SUZI-COIL DISPLAY STAND

### SUZI-COIL DISPLAY STAND GP-SCS-13

Powder coated steel frame comes with advertising header panel.

Peg board front allows display of additional products.



1740H x 500W x 660D



### COUPLING SETS

- Trailer coupling set (Non-Sealing) #GP-90-02
- Suzi-Coil coupling set (Non-Sealing) #GP-90-01



MOBILE DOT FITTING STORAGE SYSTEM. QUICKLY IDENTIFY AND ACCESS YOUR FITTINGS!

## GPRK-DOT-068

1780H x 530W x 650D

Mobile storage unit perfect for the workshop or the shop floor.

- Workshop & retail applications
- Neatly store all your fittings
- Clear front bins to easily see stock levels
- Lockable wheels
- Double sided for maximum storage
- Tall space saving design
- Header card mount for Advertising on top of the unit.



**DQ64DOT06**  
**3/8" UNION TEE**

### FITTING IDENTIFICATION LABELS

All bins come with printed labels that instantly identify fitting configuration, tube and thread size.\*



DOT FITTING CABINETS -  
SECURELY STORE AND ACCESS YOUR FITTINGS!

### GPFC-DOT-30

760H x 620W x 300D



### 2 X GPFC-DOT-30

1690H x 680W x 435D

### 1 X GPFC-DOT-30

Fitting Cabinet Stand



### FITTING CABINET

Lockable cabinet with perspex door and clear fronted bins enables easy access and quick recognition of fitting stock level.







# NOTES

---

---

---

---

---

---

---

---

---

---

---

---

---

---

---

---

---

---

---

---

---

---

---

---

---

---





# UNCOMPROMISED ENGINEERED PRODUCTS

PRODUCTS CONFORMING  
TO AUSTRALIAN STANDARD ADR-38/05



**GENERAL**  
PNEUMATICS

General Pneumatics Pty Ltd trading as  
GP Truck Products

## **GP TRUCK PRODUCTS**

Victoria, Australia  
Phone +61 3 95801811  
Fax +61 3 95801822  
sales@gptruckproducts.com.au  
www.gptruckproducts.com.au

sales@generalpneumatics.com.au  
www.generalpneumatics.com.au